



NATIVE CHILD
AND FAMILY SERVICES
OF TORONTO

Learning Series

Family Finding

Agenda

1. Welcoming Terri Jaffee
2. Opening with Vivian Roy
3. Jeffrey Schiffer
4. Mary-Ann Rice
5. Tammi Ferguson
6. Mark Atanasoff
7. Vivian Roy
8. Questions





Jeffrey Schiffer





Mary-Ann Rice



FAMILY FINDING PRESENTATION

OUR JOURNEY

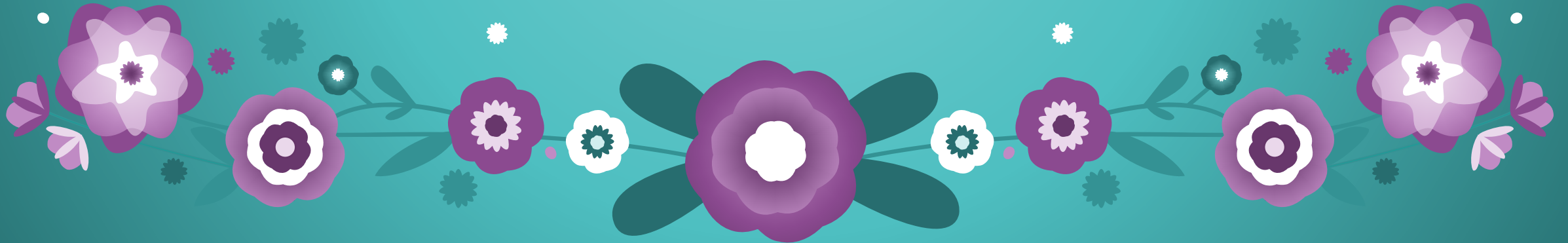

Introductions

Mary Ann
Tammi

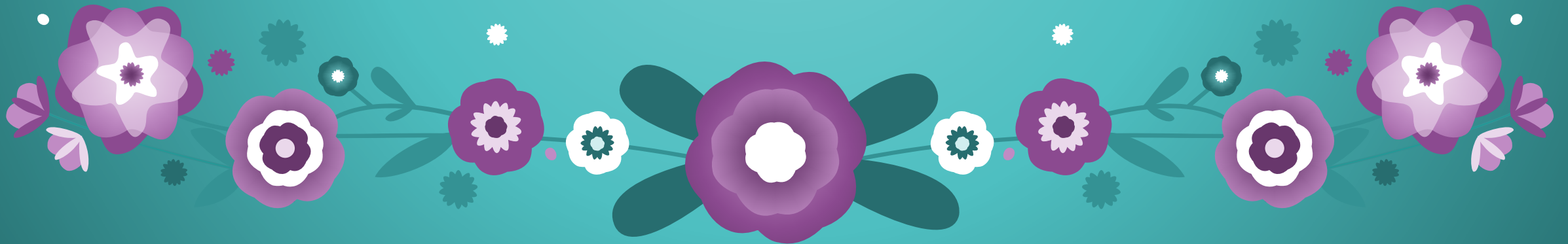

OUR BEGINNINGS

- In 2018 Native Child and Family Services of Toronto began the journey of providing Toronto's Indigenous Community Family Finding Services, initially called Kin Finding.
- In part due to the influx of Indigenous children into care, and the acknowledged difference between Indigenous and non-Indigenous approaches to Parenting.
- Child welfare have increasingly acknowledged the significance of culture and there is greater recognition of the nexus between cultural strength and children's well being .
- Native Child and Family Services of Toronto's Family Finding Team is dedicated to building and/or maintaining a lifetime of family support networks for children who are disconnected or at risk of disconnection from their family, community or culture.

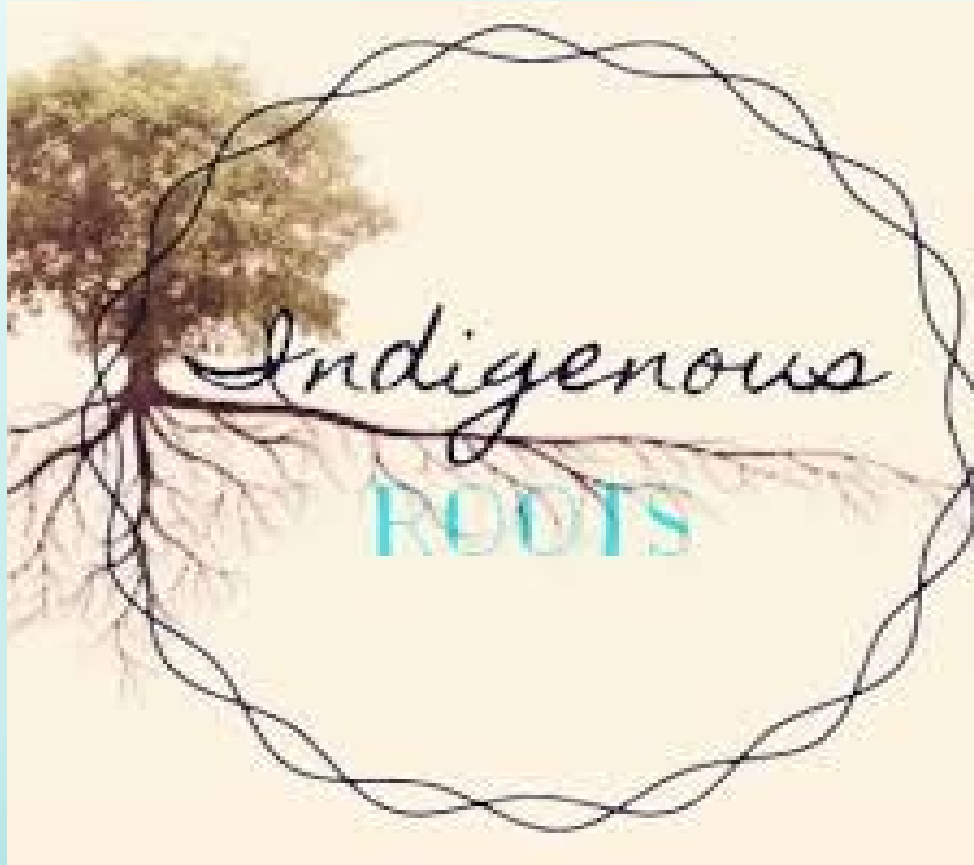

wâhkôhtowin

In the Cree language wâhkôhtowin means kinship. It refers to the concept that everything in creation is related.

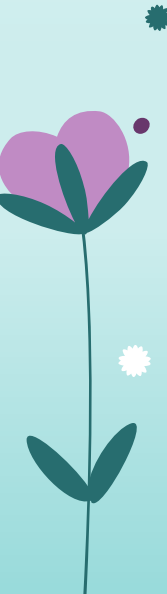

Guiding Principles

- Native Child and Family Services of Toronto's Family Finding Services Team is dedicated to building and maintaining family support networks for children and youth who are separated or at risk of being disconnected from their home, traditional communities and culture. The Family Finding Services Team ensures that the spiritual, physical, emotional and mental well-being of Aboriginal children, youth and families remains healthy and strong by exploring and nurturing crucial family and community networks meant to last a lifetime.
- Family finders seek to empower and improve outcomes for our children and youth by encouraging decision making and planning with parents and caregivers who are unable to provide immediate care while on their journeys of healing and recovery. Our practice is grounded in admission prevention network building through the identification of relatives or supportive adults who may be estranged or unknown to our families.
- We recognize that the families we work with may have relocated to other communities across the province and Canada and may have lost touch with significant relationships. By reaching out and reconnecting, the Family Finding Services Team seeks to re-establish important bonds, especially with those who are willing to provide permanent, meaningful relationships for children and youth in our care or in need of alternative care placements



Bill C-92 – An Act Respecting First Nation, Inuit and Metis children, youth and families

Indigenous siblings should be kept together provided it is in their best interest

Indigenous children in care keep strong emotional ties with their family and stay connected to their communities and culture

There is an *on-going* obligation to re-assess the possibility for an Indigenous foster child to reside with one of the parents or an adult member of their family

When an Indigenous child is not placed with a member of their family, their attachment and emotional ties to family are to be promoted.

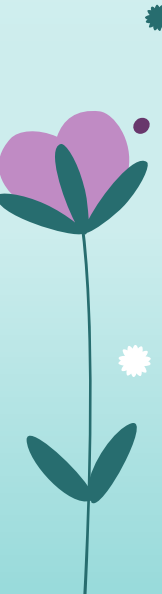

Highlights of Bill C-92

- Based on 3 principles:
 - Best interests of the child to be a primary consideration wherever a decision/action is taken
 - Cultural Continuity
 - Promote substantive equality between child and other children
- Order for priority of placement to the extent consistent with best interests of child:
 - Parents
 - Family
 - Same Indigenous community/group/people
 - Others
- Placements with or near siblings ***must be*** considered
- Priority to be given to prenatal care which is likely to be in the best interests of the child after birth, to prevent placement at birth

Two Unique but Interchangeable Roles

Family Finding

Family Finding:

- To identify potential caregivers when an alternate placement is required
- To assist with connecting children to their unique culture and/or community (if known)
- To support a youth or child with connecting with their biological parents, siblings and extended family
- To provide cultural support to kin caregivers, youth and children as needed
- Uses a variety of tools to search for and connect with extended family to build a 'community of support for children and youth

Kinship Service

Kin Service in a nutshell:

- Completion of the Kin Initial and Comprehensive Assessment when a potential caregiver has been identified
- Provide financial support in the form of monthly per diems, start up funds, and gift cards
- Provide cultural items and resources to caregivers as needed
- Honors the unique joys and challenges that Kinship Service caregivers encounter and assists with navigating the challenging child welfare system
- Supports CFWB to ensure that Kinship placements are a safe and viable option, and that the child can maintain connections to family and culture

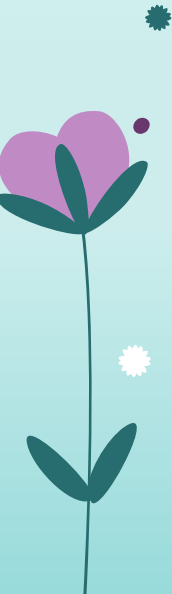
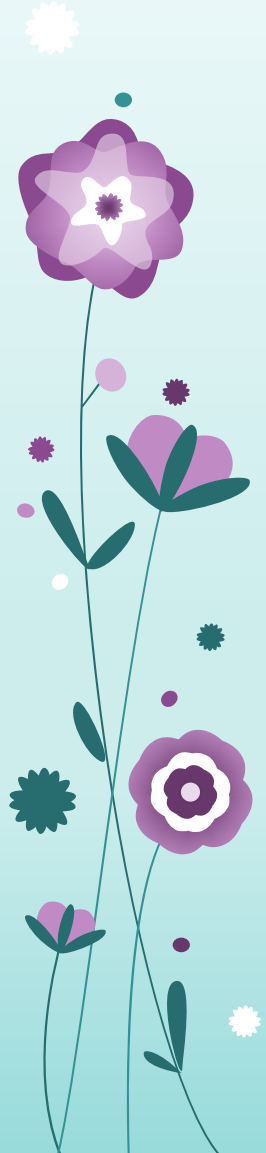

Family Finding

Family Finding is not just about finding potential alternative placements for children, the Family Finding team also makes it a priority to search for connections for children and youth

Connections within their extended family, their community or with kith (any person who is not biologically related to the child)

*There are no boundaries when it comes to Family Finding
(Story of a youth connecting with mom & siblings, Chennell)*

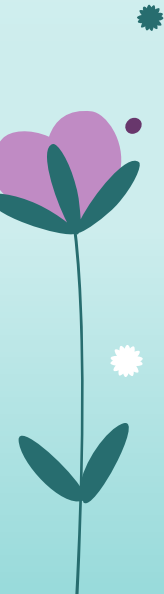
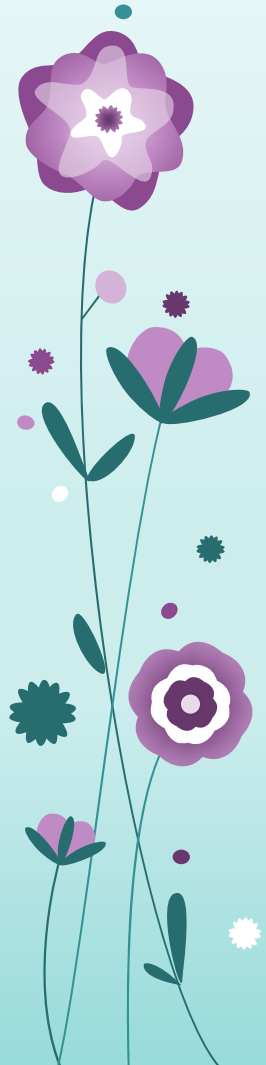

Referrals to the Family Finding team

- When a child is moved to a Place of Safety, the Family Finding team is notified immediately and a Family Finder is assigned. The Supervisor and assigned worker attend the 72-hour meeting to gather information on how Family Finding can support the family and any possible leads on family or community connections
- CFWB also sends referrals to Family Finding when there is a risk of removal to explore kin connections and as a preventative plan to support the family.
- CFWB will also make referrals as part of Pregnancy Planning. Family Finding can explore potential kin so that *if needed*, the infant can be placed with family upon discharge from the hospital after the birth.
- Family Finding also receive referrals from the Children's Services team for children and youth to build cultural, community and family connections.

Initial Kinship Assessment

Through a series of interviews with the identified caregivers this assessment focuses the interviews on a couple of areas:

- Caregiver's relationship with the child and parents
- Parenting practices, i.e., discipline, managing of special needs
- How the caregiver will support access with parents
- What supports the caregiver will require to provide adequate care of the child
- Brief summary of the caregiver's childhood and current life circumstances

The Family Finder will also request the following documents be provided:

- Criminal reference checks for all adults over 18 residing in the home
- Sign consents for child welfare checks
- Medical report from the caregiver's family doctor
- Home Safety

Initial Assessment Cont'd

- Depending on the relationship between the potential caregivers and the child, access visits may be scheduled as part of the assessment or to assist in building the relationship between the child and the Kin family
- These visits often start off at the NCFST access center and then move to the caregiver's home
- There is no one size fits all when it comes to how these visits occur; we tailor the visits depending on the needs of the family, as well as of the child to ensure a successful transition into the caregiver's home
- Once the Initial assessment has been approved the Family Finding team and Child and Family Wellbeing, then we decide on a date when the child can be formally placed in the Kin home.
- After placement both the Child and Family Wellbeing worker and the Family Finding continue to support the home to ensure that the placement is successful

Permanency Planning

Permanency planning is a vital aspect of the Kinship assessment

While the goal is always reunification with parents, we also need to ensure that 'if required', caregivers will be able to provide permanent care for a child

Discussions on permanency will take place on an ongoing basis and we honor the journey that Kin caregivers take to provide permanency



Comprehensive Assessment

- The Comprehensive Assessment is completed 90 days after the child is placed in the Kin home
- The focus on this assessment is on how the child has transitioned into the home and how the Kin family has adjusted to the placement
- We can also add any information that was not included in the Initial assessment due to time restraints
- The purpose of this assessment is to ensure that the caregiver's are receiving the support that they require and that the child and family have adjusted well to the placement.
- It is also a good time to review the permanency plan to ensure that everyone is aware of the expectations regarding permanency



Tammi Ferguson



What Happens When

There have been a few occasions when we have not been able to approve potential caregivers for a variety of reasons, including caregivers themselves making the decision that they could not move forward with the placement

We always look at creative ways to keep families connected, even when placement is not being considered

(story of child who is now connected with siblings who have been adopted through pictures and letters from Andi)

What Family Finding Can do for the Community

- The Family Finding Team can assist in searching for family and/or community members for a child who has or will be removed from their home.
- The team provides cultural connections and completes kin out of care assessments. After the child is placed, the team provides support to the kin family to ensure the placement is successful.
- We can support families with a per diem to stabilize and maintain placements.
- We can explore family, community and cultural connections in order to increase the circle of care and lifelong connections for children and youth.
- We continue to work on revamping forms, attend training, provide presentations to teams/departments and ensure that our work promotes the circle of care needed to have the child at the centre of this process.

Working Together with First Nation Communities



A story of Family Finding reaching out to the First Nation community in their search for family connections, which led to a placement with grandparents in Saskatchewan.



Family Finding Methods

- Connecting with the bio parents to explore who they feel can support them and potentially care for the child if needed
- Connecting with the First Nation if not already done to ensure that they are actively involved in the decision making
- Use of social media platforms such as Facebook and Instagram when we have names but no other contact information
- Connecting with the youth and/or their worker to discuss how Family Finding can support
- Thorough review of the file history

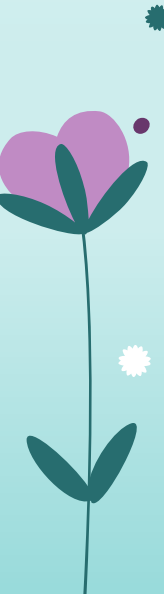

Benefits of Placing with Family

- Builds on existing relationships and promotes stability for the child/youth
- Minimizes the impact for a child being removed from primary family and/or community.
- Encourages and empowers parental involvement in decision making and planning for the child/youth
- Increases the likelihood of reunification with the primary family

Walking Together with Families

- The Family Finding team places high value on working together with Kin families as we view them as the ‘experts’ of their own unique family situation
- By honoring, respecting and listening to families we can weave a fabric of permanency around the child outside of adoption or remaining in long term foster care
- The Family Finding team continues to be creative in providing support to families that is tailored to each individual family’s unique needs

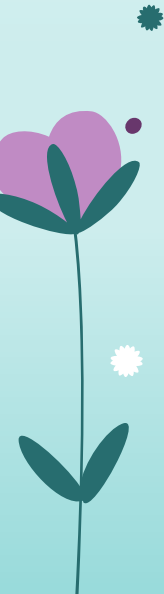
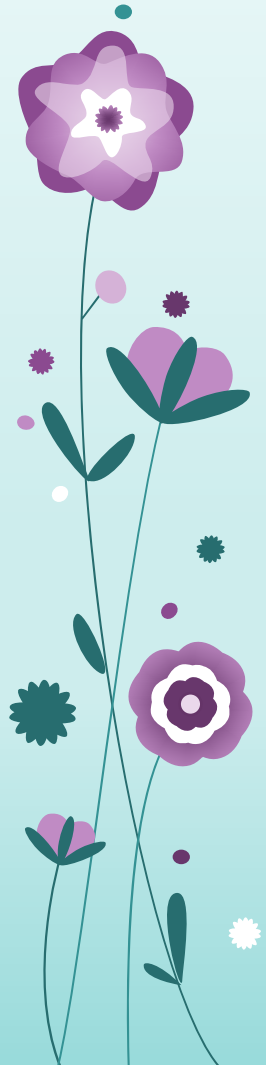

Current Stats

- Family Finding is currently supporting 55 children with a monthly per diem
- Along with the monthly per diems, Family Finding continues to support families financially with start up costs and cultural supports on an as needed basis
- The Family Finding team have significantly increased their social media presence, particularly on Facebook and Instagram and has had great success connecting with extended family through these outlets

Family Finding Team Events

- The Family Finding team celebrated Kinship Awareness Week in 2021 by providing Blanket gift bags to families. The gift included a fleece blanket, medicines and a pamphlet on the four sacred medicines. The gifts were delivered in person to the families by either the Family Finder or the CFWB worker
- On March 3rd of this year, the Family Finding team held a virtual Kinship Gathering/Lunch and Learn co-facilitated by Kevin Fujita. Ten caregivers joined the team for this event to talk about the importance of family and it was a great opportunity to meet the Family Finding team and connect with other Kinship Caregivers.
- The team has also purchased cultural items to give to families as needed. The items include smudge bowls, rattles, dream catchers and a diverse collection of books for children of all ages. The team has also purchased a collection of books that represent the Afro-Indigenous population that we serve.

Success Stories

Family Finding has been actively involved in repatriating children with families not just in the Ontario, but also to other jurisdictions such as:

- Nevada
- Saskatchewan
- Newfoundland
- British Columbia

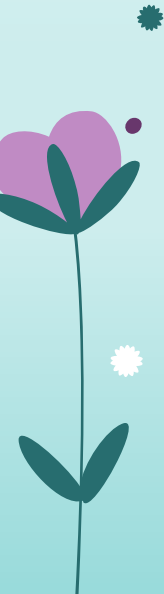
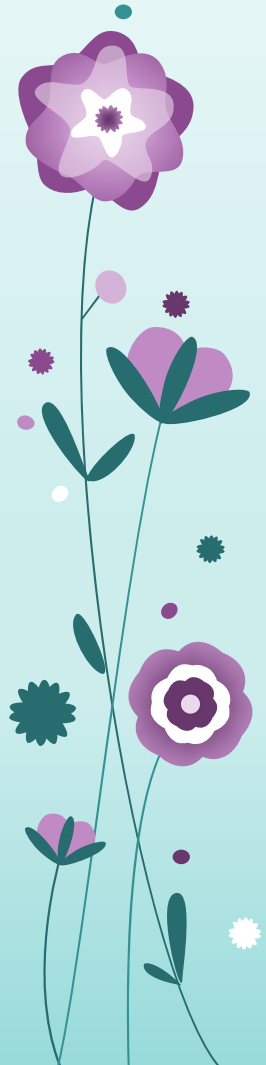

Personal Story of a Kinship Placement

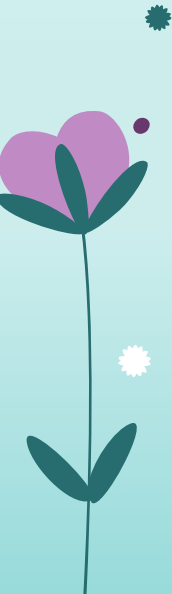
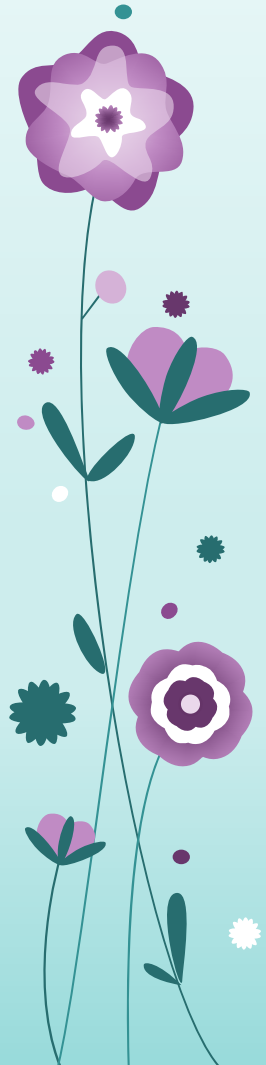

Being Creative

Some youth have just asked for information on their extended families, even though they may not feel ready to reach out to make a personal connection. The Family Finder will try to obtain family information through speaking with the child (if appropriate), reviewing the file history, connecting with their identified community and speaking with their worker. This information is put into a genogram that lists their family members and how they are connected. Family Finders try to provide as much information as possible, including contact information (if it was obtained) so that the child or youth can reach out to their family members when they feel ready to do so

Example of a genogram

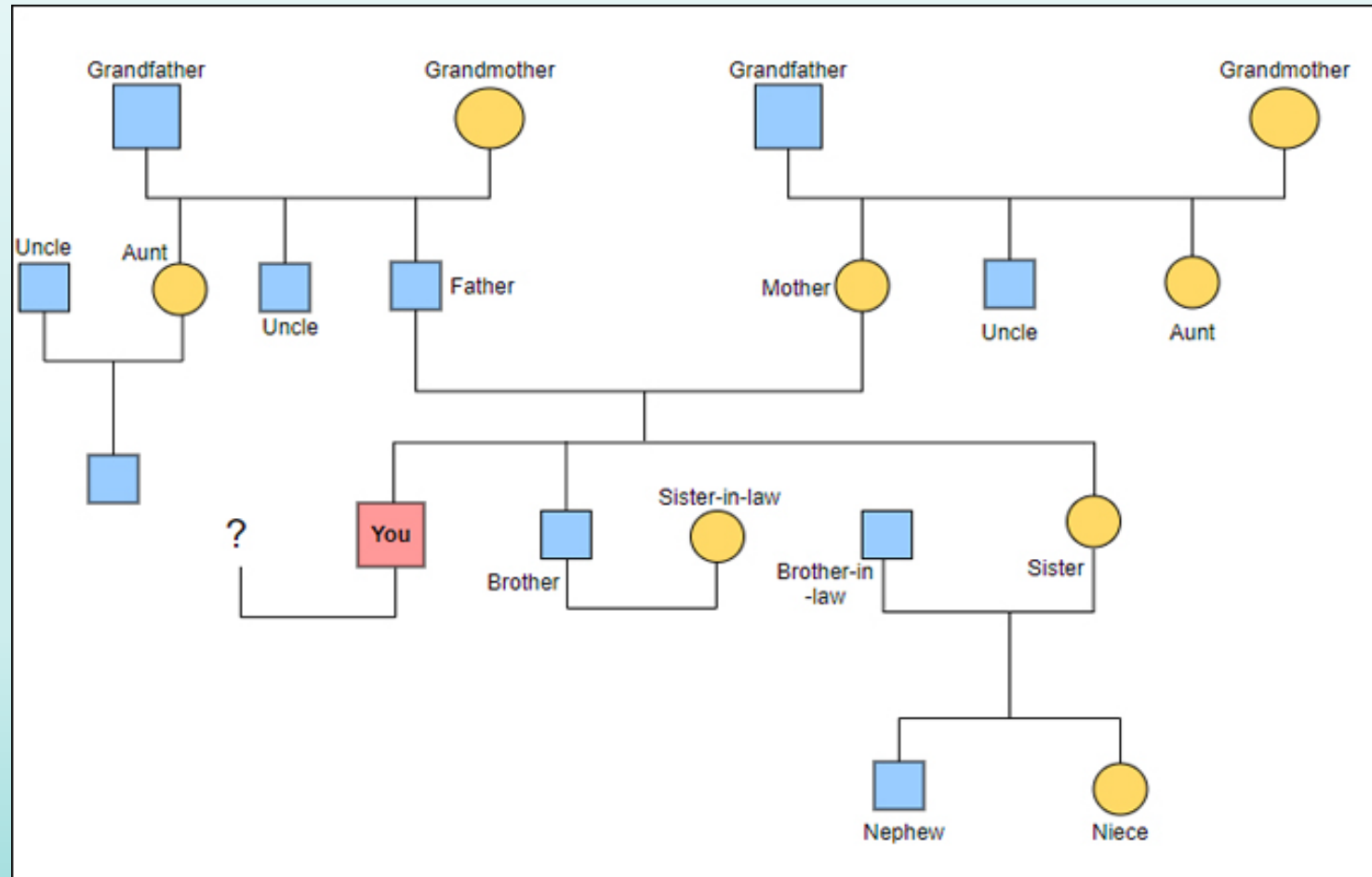

Challenges associated with Family Finding

- Parents not want to provide information (may be feeling shame and not wanting their family to know how much they are struggling)
- Stigma of working with a child welfare agency, lack of trust because of the history of child welfare with the Indigenous community
- Kin caregivers hesitant to be involved with a child welfare agency
- Many extended family members may not be able to present a plan to care for another child as they may be on their own healing journey
- Adoption laws can make it difficult to get information on adoptions, especially if the adoption was completed by another child welfare agency
- When we are not able to get consents for Family Finding and not knowing from a legal perspective when we can search and when we can't
- Equality with Kin in Care; Kin Service families are often not included in supports that Kin in Care caregivers have access to



Miigwetch
Nya:wen
Thank you

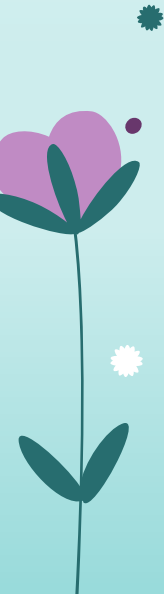



Mark Atanasoff



Reform Pillars

Community
Programs as a
System

Reducing Children in Care
(Improving Community Level Outcomes)

Family
Networks to
Thrive

Reducing Crisis
(Empowering Families & Natural Supports)

Child Welfare
Reform

Reducing Trauma
(Striving to make Child Welfare a Voluntary Service)

Reconciling Child Welfare Within Community

Reducing Stigma & Shame
(A resource for families & part of a healing journey)



Child Welfare Reform Details

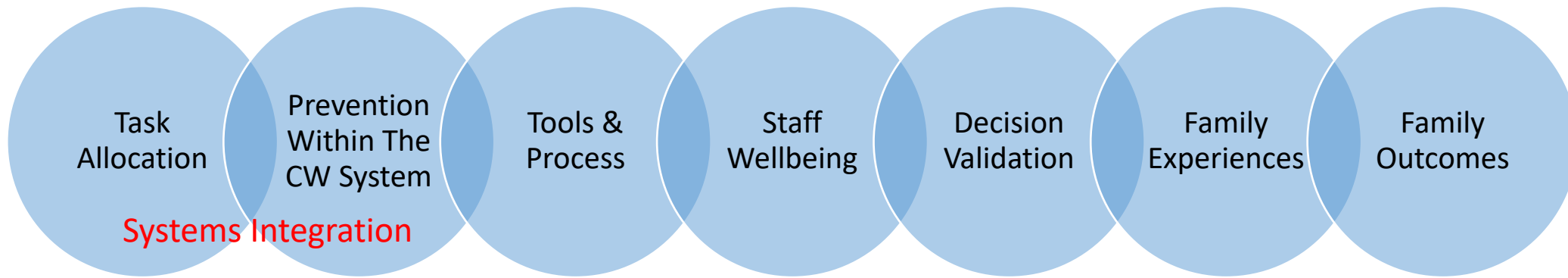

Indigenous World View / Best Interest of the Child / Self-Determination (Bill C-92)

What is Important to Community

(Language, Culture, Connection to Family & Community)





Vivian Roy





Questions





Miigwetch!

